

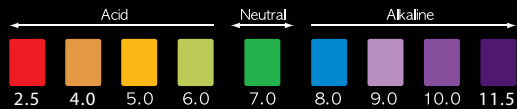

www.tyentusa.com

- The user is responsible for improper use of the products such as use in any manner for which the product was not originally intended and any damage that may occur from such improper use.
- This product is subject to changes that enhance its performance without prior notification.

pH Chart



How to Measure pH: Place approximately 2 table-spoons (30mL) of test water in a container and add 4 drops of pH reagent. Then, mix well and check the color of the water with the pH chart above (The color of the water will change according to its pH.)

- If the power cord is damaged, it must be replaced by the manufacturer, or a similarly qualified Tyent repair person in order to avoid a hazard.
- This appliance is not intended for use by persons (including children) with reduced physical sensory or mental capabilities or lack of experience and knowledge, unless they have been given supervision or instruction concerning use of the appliance by a person responsible for their safety.
- Children should be supervised to ensure that they do not play with the appliance.

MADE IN KOREA



TYENT User Manual hybrid

- This product is intended for domestic use only.
- Keep this User Manual handy for easy reference.
- Carefully read this User Manual, particularly "all safety warnings."



WATER FOR WELLNES

To Our Valued Customers

Thank you for purchasing the **Hybrid Water Ionizer**. Please read all safety warnings and this User Manual carefully before using this product to ensure proper product usage. (Keep the manual handy for easy reference.)

- We are not responsible for any accidents and/or malfunctions due to the improper use of this machine
- Please keep the manual and warranty card in a safe place, so that it's easily accessible when you need it
- Please refer to this manual often when you have questions when using or when troubleshooting this unit

Intended Use

This device creates **functional alkaline ionized and molecular Hydrogen enriched water**. It changes the properties of regular tap water through the use of electrolysis. Following are the changes normal tap water undergoes via this process:



- An increase or decrease in pH level
- Creation of negatively charged hydrogen ions (antioxidants)
- Purification through filtration
- An increase in molecular hydrogen

Table of Contents

- To Our Valued Customers 2
- Table of Contents 3
- Before Usage 4
- Safety Precautions and Warnings 5
- Product Features 10
- Package Contents 12
- Unit Overview 13
- LCD Display and Touch Pad Overview 14
- How to Install the Unit 16
- Water Hose Installation 18
- Directions for Product Use 20
- System Setup Mode 21
- Customer Serviceable Parts 24
- How to Change the Filters 25
- How to Reset the Filters 26
- Cleaning Function 27
- TURBO Function 28
- Unit Specifications 29
- Troubleshooting 30
- Product Warranty 31

Before Usage

Safety precautions are provided for the safe and proper use of this unit and can prevent danger, bodily harm and/or possible damage due to misuse. Please make sure you are familiar with all the safety precautions and warnings associated with this unit.

	DANGER (Red Warning Sign) indicates an imminent hazard that could result in serious injury or death. If you see this sign, stop using this unit immediately.
	WARNING (Orange Warning Sign) indicates a potential hazard that could result in significant bodily harm or damage to the unit. If you see this sign, stop the use of this unit.
	ATTENTION (Yellow Warning Sign) indicates a potential hazard that could result in minor bodily harm or damage to the unit.

1. Do not drink functional water with medication. When taking medication, use “clean H₂O” filtered water thirty minutes prior to taking medication as well as with medication. You may resume drinking functional water thirty minutes after taking medication.
2. Always consult your primary care physician before drinking functional water. Only drink a small amount near a neutral pH level for the first week. This will give the body time to adjust to functional water during the detoxification period. See Welcome Guide for full details on getting started.
3. If you notice any negative effects from drinking functional water, stop drinking the functional water immediately and consult your primary care physician about changes in your body’s pH level.
4. If you are currently under the care of a primary care physician for an existing condition, consult your primary care physician about how changes in pH and other characteristics of functional water could affect your medical condition.
5. If you suffer from gastric acidity, kidney failure or potassium excretion, you should not drink functional water.
6. Verify the pH levels of the functional water dispensed from this unit on a monthly basis to ensure proper function. This can be done with the supplied reagent drops and a pH color chart.
7. When switching from one pH to another, it is good practice to let the water run for several seconds before using.
8. It is common to drink half your body weight in ounces. For example, if you weigh 180 pounds, it may be wise to drink 90 ounces every day of water per day. This especially applies after you have given your body some time to adjust to the new pH level.
9. The recommended drinking level for functional water is 9.5 pH (+-0.3). It is not recommended to drink functional water above a pH of 10.
10. If you wish to store functional water, use a glass or other nonleaching material with an airtight lid and store it in the refrigerator. Functional water will begin to weaken immediately and will lose most of its benefits after 3 days.
11. Never run hot water through this unit.
12. Never drink acidic or turbo water.

Safety Precautions and Warnings

This appliance is not intended for use by persons (including children) with reduced physical, sensory or mental capabilities, or lack of experience and knowledge, unless they have been given supervision or instruction concerning use of the appliance by a person responsible for their safety. Children should be supervised to ensure that they do not play with the appliance.

Regarding the Power Supply



Do not use if the power cord is damaged or in a loose power outlet.

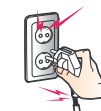

Do not pull the power cord. Never touch the power cord or the power outlet with wet hands.



Do not forcibly bend, squeeze, damage or crush the power cord under heavy objects.



Unplug the power cord during general maintenance, repair and inspection and while replacing parts.

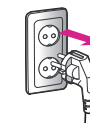

Do not use power surge protectors with this unit. Use unit with its own dedicated power source.



Only use the unit with the correct voltage. Units sold in the USA and Canada are designed to be used with between 110 and 120 volts AC. Plugging your ionizer into an outlet with a higher voltage than this will cause serious damage to the ionizer.



To reduce the risk of electric shock, do not remove the cover; there are no user-serviceable parts inside. Refer servicing to qualified service personnel. Removing the cover will void the warranty.



Installation

 Use only source water approved as drinking water by an authorized organization (i.e. tap water).

- If using groundwater, make sure the water meets drinking water compliance standards before installation. If not, a pre-filter may be required. (source water quality greatly affects pH values and filter performance)
- **Do NOT** use excessively hard water or saltwater. (may cause malfunctions and/or shorten the product life)

 Do not place this unit near heat sources.



 Do not use unfit raw water in accordance with the standards of the water service act.



 Do not use in areas of high humidity and/or high temperature.



 Do not place this unit on an uneven surface. Do not drop or use excessive force on this unit.



 Do not connect the water line to a hot water supply. Please use a new hose to connect with water line. (Do not reuse old hose as it can cause leakage.)

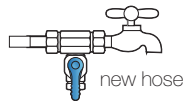

 Install the drain faucet with suction cup near your sink and adjust the position of the drain faucet's metal spout to drain into the sink.

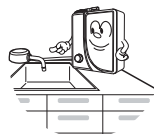

 Make sure the drain faucet is positioned lower than the unit.

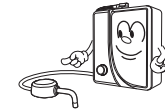

 If the unit is not used for a few days, let the water run for 1-2 minutes before drinking functional water.

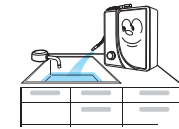

 Do not run the water for longer than 1 hour.

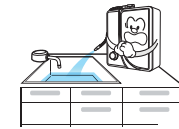

Storage

 Remove the filters and turn them upside down to remove excess water before storing.

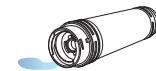

 If the original packaging is not available, cover the unit in plastic to avoid scratching.



 Store the unit in its original packaging in a cool, dry place when not in use.



 Carefully remove this unit from its packaging. Keep the original packaging for future storage and unit transportation.



Usage



If the unit won't be used for a long time, shut off the valve and unplug the power cord.

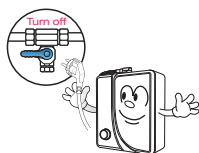

If you hear strange noises, smell a burning odor or see smoke, unplug the power cord immediately and call qualified personnel for service.



Replace filters every 6 months to optimize the purification performance of this unit even if the replacement indicator light isn't turned on.



Do not place any objects on top of this unit no matter how small they are.



If water leaks out of the unit (other than the hoses) or if the unit is standing in a puddle of water, shut off the water supply, unplug the power cord and contact qualified service personnel for service.

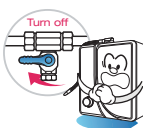

Do not use or store pH reagents near flame. (There is a risk of fire)



Do not poke or scratch the touch pad or LCD display with sharp objects.

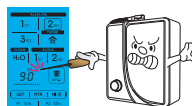

It is beneficial for the maintenance of the machine to run a strong acidic level for 5-minute cycles twice weekly. This will help to maintain a clean chamber.



In areas of hard water (calcium scaling present on faucets), notify your service provider and install a cell safe antiscaling prefilter to protect the ionizer from scaling.



Do not use alkaline or acidic water in fish bowls or aquariums. The sudden change in pH could be harmful or fatal to some marine life.



It is normal for condensation to be present on the unit during humid summer months. If condensation persists despite weather conditions, unplug the power cord and refer servicing to qualified service personnel.

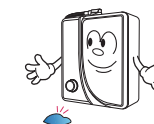

Cleaning



Do not store the unit near chemicals, food, metals or medication

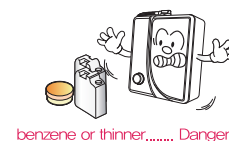

benzene or thinner..... Danger



Do not spray water on the main unit. Do not clean the unit with benzene or other chemicals, which may leak into the unit. If using a damp cloth, be very careful not to get electronic display wet.



Please clean inside and outside of the outlet tube with a soft brush. If you do not clean it regularly, scale, such as lime components (Calcium and Magnesium) may occur.

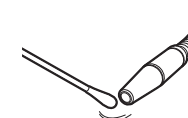

In areas with high TDS of water, calcium can collect on the tip of the outlet tube. Please keep it clean.



Product Features

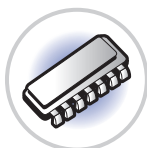

Fully automatic system with embedded central processing unit (CPU)

Every aspect of creating functional water is controlled by the CPU chip that automatically finds an optimal operating condition when in use.

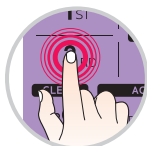

Automatic water flow

Simply pressing the touch button allows you to start and stop the flow of functional water.



Fixed quantity discharge function

For your convenience, the ionizer has the ability to dispense a predetermined amount of water and then stop. Presets include 0.5L, 1.0L & 1.5L. These presets can be further adjusted with the jog dial.



Production of 9 Different Kinds of Water

This unit is capable of producing 3 levels of alkaline drinking water, 2 levels of acidic water, neutral clean water, turbo alkaline water and acidic waters for cleaning and neutral hydrogen enriched water.



Excellent Sound Quality with Guided Support

Top-quality voice guidance system ensures that you are always informed about what your ionizer is doing.



Filter replacement cycle

This unit features a filter life cycle display and voice announcements designed to let you know when it is time to change the filters. Every 6 months is best for optimal performance.



Touch LCD display color backlight

The color back light on the LCD display allows you to distinguish alkali water from acidic water.

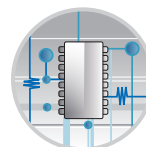

Powered by SMPS Plus Power Supply System

SMPS Plus® Power Supply System provides the maximum output needed to produce highly stable electric power required for each phase of electrolysis. SMPS Plus is engineered specifically for adjustability and variable voltage, which allows the unit to be customized for your unique source water.



Twin Cell Hybrid

World's first electrolytic twin cell with new features and designs. Enjoy maximum levels of molecular hydrogen at any alkaline level.



Filter Door Detection

When door is open, the water supply will be suspended for your safety.



Automatic Stop Function

In order to prevent the overflow of water due to user negligence, the water discharge is automatically stopped after 15 minutes of use.

*** TURBO : 5 minutes**



Eco mode

The LCD backlight will be turned off automatically during periods of non-use and the Time function is displayed.



Advanced water purification system

Perfect, seamless elimination of foreign substances including residual chlorine, organic & inorganic compounds through a filtering process using Activated Carbon and UF micro-Ceramic materials, enhancing the alkali water quality.

Safety Functions

The outflow of functional water stops automatically when raw water is not supplied, preventing the electrolytic cell and power supply unit from being damaged due to current overflow, water from being wasted and accidental water leaks. This function also allows you to set pH and ORP levels according to the amount of water inflow, to distinguish pH from backlight colors and set the auto cleaning function.

Package Contents

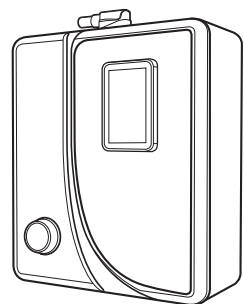

Water Ionizer

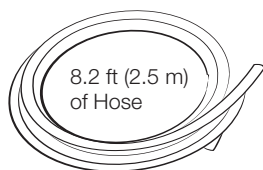

8.2 ft (2.5 m)
of Hose

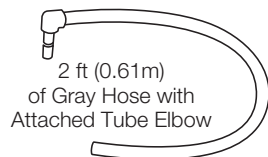

2 ft (0.61m)
of Gray Hose with
Attached Tube Elbow



Water Outlet Tube

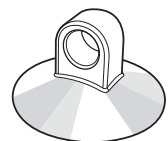

Tube Suction Cup

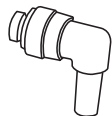

Stem Elbow

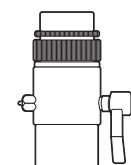

Faucet Diverter

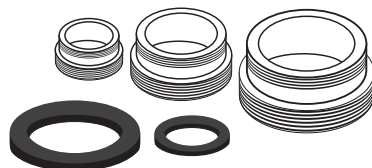

Assortment of Connectors
and Rubber Washers

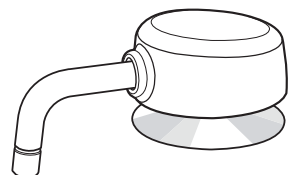

Drain Faucet
and Tube Suction Cup



pH Testing
Solution Bottle

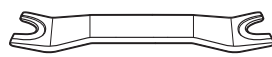

Wrench



User Manual

Tools You Will Need



Utility Scissors

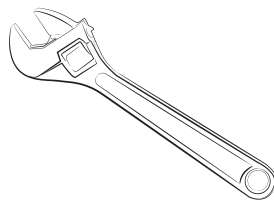

Adjustable Wrench

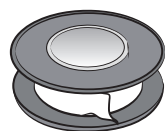

Plumber's Tape

Unit Overview

Make sure you are familiar with the parts and features of this unit, and carefully read the user manual and other important information

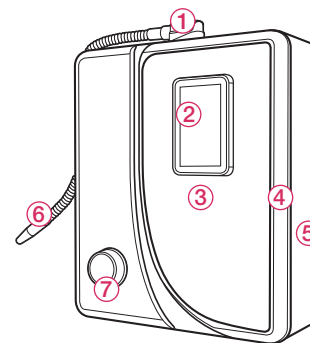

Front View

- ① Water Outlet Unit
- ② LCD Display
- ③ Front Cover
- ④ Door Case
- ⑤ Front Case
- ⑥ Water Outlet Tube
- ⑦ Jog Dial Control With Molecular Hydrogen Water (H₂ Water) Button

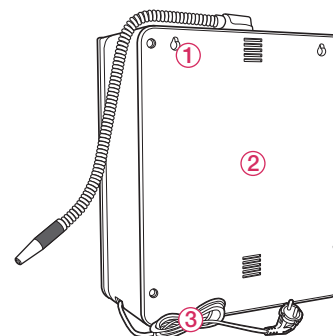

Rear View

- ① Hanging Groove
- ② Rear Case
- ③ Power Cord

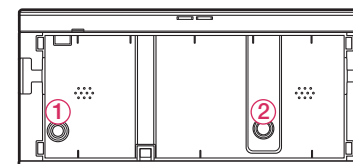

Bottom View

- ① Water Inflow
- ② Water Outflow

LCD Display and Touch Pad Overview

1 Standby screen

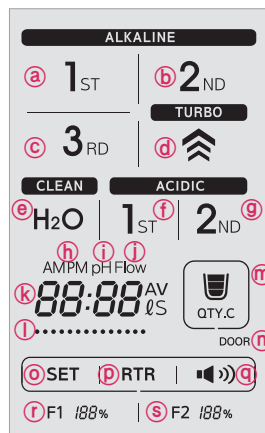

(a)	Alkaline level 1 (Hydrogen Alkaline)	(k)	Time/pH/Flow
(b)	Alkaline level 2 (Hydrogen Alkaline)	(l)	Remaining time
(c)	Alkaline level 3 (Hydrogen Alkaline)	(m)	Fixed quantity discharge
(d)	Turbo	(n)	Door open
(e)	Purified water	(o)	System set up
(f)	Acidic level 1	(p)	Cleaning
(g)	Acidic level 2	(q)	Voice on/off
(h)	AM/PM	(r)	1st filter indicator and reset
(i)	pH indicator	(s)	2nd filter indicator and reset
(j)	Flow indicator	(t)	Jog Dial Control With Molecular Hydrogen Water (H2 Water) Button

2 Water Outflow screen

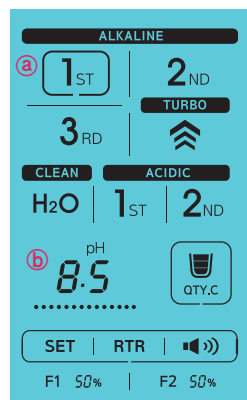

- (a) The outflow button of the selected level will flash.
- (b) The following information is displayed in order.



pH indication of selected level



Indication of the current amount of flow



Indication of the remaining time of flow

3 Display color

The backlight color of all outflow levels light up by response color of standard colorimetric paper. By using the backlight color, the level is distinguished and prevents drinking Acidic water.

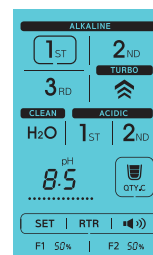

Alkaline level 1 (Hydrogen Alkaline)



Alkaline level 2 (Hydrogen Alkaline)

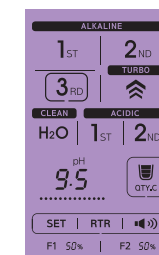

Alkaline level 3 (Hydrogen Alkaline)



H2 water

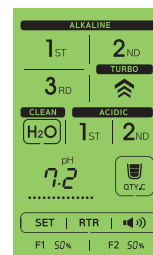

Purified water



Acidic level 1
※Do not Drink



Acidic level 2
※Do not Drink



Turbo
※Do not Drink

※The pH value of each level is the standard value based on the test water.
※Depending on the quality of the raw water used, the flow rate, the water temperature, etc., the actual number of functional water may be different.

Backlight of LCD display will match the pH level color according to water pH level being used after icon is pressed.

How to Install the Unit

Determine whether you will connect the unit directly to the cold water supply line (under sink) or to the faucet (see image).

- **Option A | Faucet:** A faucet connection requires a faucet diverter (included).
- **Option B | Under-Sink:** An under sink connection requires an under-sink adapter kit (not included) or a compatible t-valve (available from most hardware stores). For more information see Welcome Guide or call support.

Option A – Faucet Installation

Many faucets vary in design, and your faucet may require different setup instructions than those featured in this manual. Please consult a qualified service professional if you are unable to correctly complete the installation.

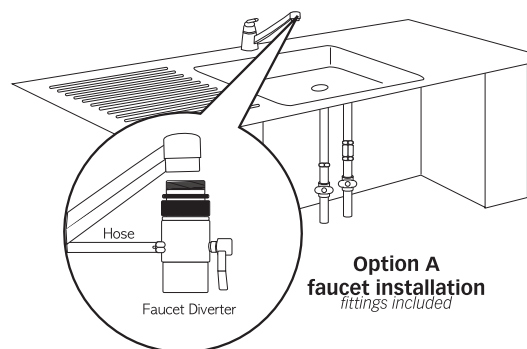

- ① Shut off both the hot and cold water main supply at the pipe under the sink.
- ② If your faucet features a screw-on style aerator, remove it by unscrewing it from the tip of the faucet.
- ③ If the included faucet diverter does not fit directly to the tip of the faucet, select an appropriate size connector and rubber washer (included).
- ④ When connecting the diverter or adapter to the faucet, be sure to use plumbing pipe thread seal tape also known as plumber's tape or teflon tape (not included) to prevent leaks.
- ⑤ If necessary, connect the faucet diverter with the appropriate connector to the faucet.
- ⑥ Be sure all connections are secure but do not overtighten them.

Option B – Under-Sink Installation

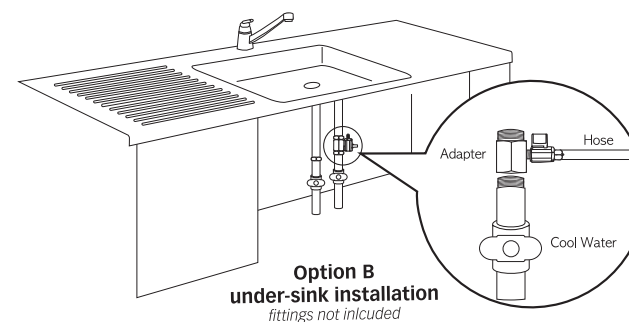

- ① Purchase either an under-sink installation kit (not included) or purchase a T-connection (with shut-off valve) from a hardware or plumbing supply store.
- ② Shut off both the hot and the cold water main supply at the pipe under the sink.
- ③ Locate the cold water supply line valve.
- ④ Disconnect the faucet cold water supply line from the main cold water pipe. Use a towel to catch the small amount of water that may come from the faucet supply line.
- ⑤ When connecting the T-connection to the cold water pipe, be sure to use plumber's tape or teflon tape (not included) to prevent leaks.
- ⑥ Reconnect the faucet's cold water supply line to the T-connection (now secured to the main cold water pipe).
- ⑦ Be sure all connections are secure but do not overtighten them.

Both Options

Do not turn on the main water supply until all hoses are properly installed to the unit. The unit and components are subject to change without prior notification in order to enhance performance.

Water Hose Installation

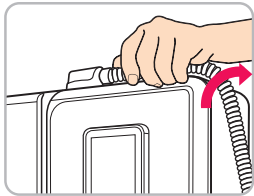

- ① Place the unit on the planned installation location and screw the flexible tube clockwise into the water outlet hole positioned at the top of the unit. Do not over tighten.

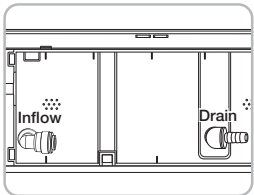

- ② Press the stem elbows into the water inflow and outflow holes on the bottom of the unit until you hear a click and feel the hose sit firmly in place.

How to Install the Drain Faucet

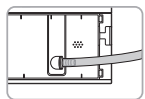

- ① Connect the drain hose tube elbow to the outflow hole located at the bottom of the unit.

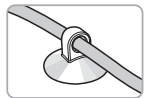

- ② Connect the drain hose to the tube suction cup and secure it so that it does not move.

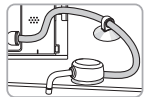

- ③ Connect the drain hose to the faucet and secure it to the proper position on the sink.

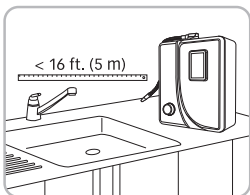

- ③ Measure between the unit's location (on the counter) and the water faucet (or under-sink T-connection) where the diverter (or T-connection) will be installed. Cut enough hose to allow an easy connection from the rear of the unit to the water supply (either using the faucet diverter or the under-sink T-connection).

Note: Keep the length from the unit to the faucet under 16 feet (5 meters). You may need a pressure pump or a larger size hose if the pressure is too low. Be sure to leave a few extra inches (centimeters) of length so the faucet can still be rotated.

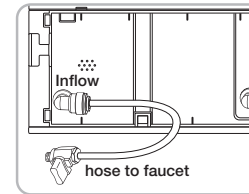

- ④ Connect the hose from the inflow hole to the cold water supply either at the faucet diverter using Option A, or the under-sink T-connection using Option B.

Option A: Remove the nut from the diverter, slide the nut onto the hose, then firmly seat the hose on the faucet diverter and screw the nut over the hose and back onto the faucet diverter.

Option B: Route the hose through the countertop to the T-connection, then firmly seat the hose on the T-connection and make sure the connection is sealed completely.

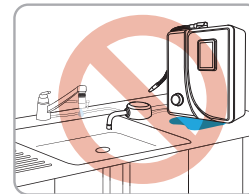

- ⑤ Make sure all hose connections are firmly seated in the correct holes, both on the unit and at the water supply

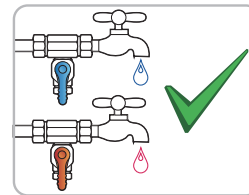

- ⑥ Turn on both the cold and hot water supply. Make sure there are no leaks at any of the connections. Make sure the faucet is working with both hot and cold water. Make sure there are no leaks from the hose connections on the bottom of the unit. Make sure the hoses are firmly seated in the unit holes.

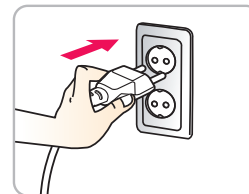

- ⑦ Plug in the power cord. You should hear a series of tones when you power up the unit.

Directions for Product Use

1 How to Select Alkaline Water from the Unit



- ① Press the desired icon on the LCD screen.
 - ② The selected icon will flash during water outflow.
 - ③ If you press the selected icon that's flashing, then the water outflow will stop.
- ※ If the selected icon is not pressed again, the unit will automatically stop after 15 minutes of water outflow. (Turbo: 5 minutes)

2 How to Select Hydrogen Water from the Unit



- ① Press the Hydrogen water button at the bottom of the unit.
 - ② Hydrogen water will begin to pour from the metal flex hose at the top of the unit.
 - ③ Press the button again to stop the outflow of water.
- ※ If the selected button is not pressed again, the unit will automatically stop after 15 minutes of water outflow.
- ※ When you press the Alkaline level 3 button, the water that comes out is both alkaline AND hydrogen enriched.

3 How to Set up the Quantity Discharge Function

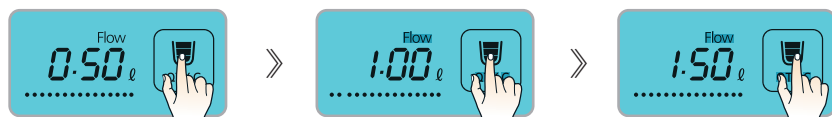

- ① For initial setup, press the QTY, C icon and choose the fixed amount of water quantity. (0.5L → 1.0L → 1.5L → release).
- ② When initial setup is complete, press the water outflow button.
- ③ The water outflow will stop automatically once the fixed amount of water quantity is discharged.

4 How to Set up the Quantity Discharge Function(Jog Dial)

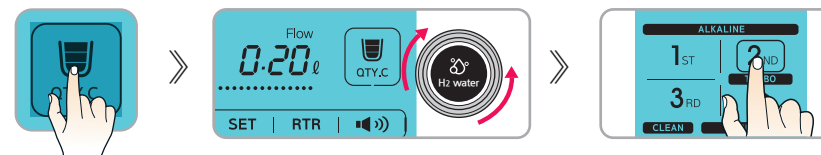

- ① Touch the "QTY.C" button and select the quantity amount you'd like to modify (0.5L, 1.0L, or 1.5L)
- ② You can fine tune the exact amount of water you need by turning the jog dial.
 - Clockwise : Increasing by 0.1L (Max. 5.0L)
 - Counterclockwise : Decreasing by 0.1L (Min. 0.2L)
- ③ Push the Alkaline or Acidic level of water you desire.
- ④ Water outflow will automatically stop after dispensing the fixed amount of water you selected. (Discharge of water will stop when you touch the button while water is coming out.)
- ⑤ After water comes out, fixed quantity discharge function is released.

System setup mode

1 pH level adjustment



- ① Enter the system setting mode by pressing the **SET button** on the LCD for 3 seconds. (Beep twice notifications)
 ※Voice message : "System setup mode."

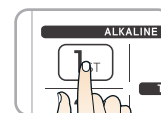

- ② Press the **desired water level button** for 3 seconds to enter the pH setting mode of the selected level. (beep twice)

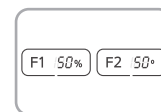

- ③ Use the F1(-) and F2(+) button to adjust the level.
 ※ F1 : Decrease / F2 : Increase
 (Adjustable by Jog dial)



- ④ Press the **SET button** for 3 seconds to complete the setting and return to the stand by screen. (Beep twice notifications)
 ※Voice message : "Setup was completed."

2 How to select language



- Enter the system setting mode by pressing the **SET button** on the LCD for 3 seconds. (Beep twice notifications)
*Voice message : "System setup mode."



- Enter the the language setting mode by pressing the **Voice button** for 3 seconds. (Beep twice)

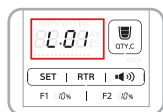

- The display shows the language currently set in the code. Use the F1(-) and F2(+) button to adjust(Adjustable by Jog dial) the language and to select the desired language. (When you select a language, you will be announced by the selected language)



- Press the **SET button** for 3 seconds to complete the setting and return to the stand by screen. (Beep twice notifications)
*Voice message : "Setup was completed."

3 How to set the time



- Enter the system setting mode by pressing the **SET button** on the LCD for 3 seconds. (Beep twice notifications)
*Voice message : "System setup mode."



- Enter the the time setting mode by pressing the **QTY,C button** for 3 seconds. (Beep twice notifications)



- Each time you press the **QTY.C button**, the adjustment position changes to **AM/PM-Hour-Minute**.

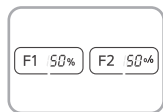

- Setup the time by F1(-) and F2(+) button.
* F1 : Decrease / F2 : Increase
(Adjustable by Jog dial)

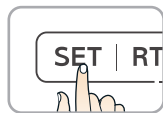

- Press the **SET button** for 3 seconds to complete the setting and return to the stand by screen. (Beep twice notifications)
*Voice message : "Setup was completed."

4 Volume Level Adjustment



- Enter the system setting mode by pressing the **SET button** on the LCD for 3 seconds. (Beep twice notifications)
*Voice message : "System setup mode."

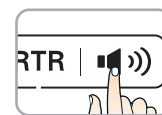

- Press the Voice button to set the volume.

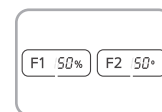

- Control the voice volume by F1(-) and F2(+) button.
* F1 : Decrease / F2 : Increase
(Adjustable by Jog dial)



- Press the **SET button** for 3 seconds to complete the setting and return to the stand by screen. (Beep twice notifications)
*Voice message : "Setup was completed."

5 Selecting Voice On/Off

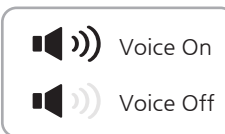

- The voice will be turned on/off by press the voice button.

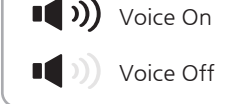

- Voice message
- On : " Voice function works "
- Off : " Voice function terminates "

6 ECO mode

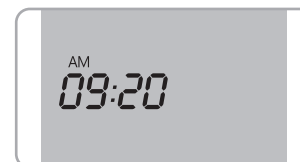

- If the product does not operate for 10 minutes, it will switch to ECO mode. The display turns off automatically and switches to the clock mode.
- Touch the control panel to turn the display back on. At this time, the display screen is displayed as the information of the last level of outflow.

Customer Serviceable Parts

ATTENTION: If do not use the TYENT original filter or parts for replacement, it will cause product malfunction and we cannot provide warranty.

***If you do not use TYENT original filters, the following problems will occur.**

- Cannot provide product warranty.
- It may cause product leakage.
- It may cause product malfunction.
- Filter performance is significantly reduced.
- The life of the product is shortened.



Primary Filter: **YT20 1st Filter**

Recommended filter replacement cycle:
(Every 6 months)

Removes harmful chemicals like chlorine, compounds such as agrichemicals and detergents, large suspended matters like rust and sediments as well as other volatile organic compounds through an efficient activated absorption method. It also eliminates bad smells and any remaining dissolved chlorine.



Secondary Filter: **YT20 2nd Filter**

Recommended filter replacement cycle:
(Every 6 months)

0.01 micrometer filtering film filters contaminated materials including ordinary bacteria, etc. and maintains the minerals in the water.

The life of the filter can vary greatly due to use, water pressure, water quality and the changing of the seasons. Filters may need to be replaced sooner than the scheduled time due to these reasons, you may notice reduced water quality or declining water taste.

How to Change the Filters

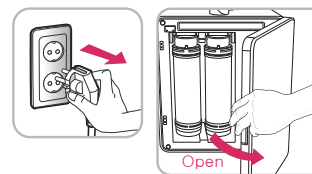

1. Shut off the water supply to the unit and unplug the power cord. Open the door in front of the product.

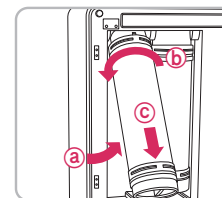

2. Remove old filter:
 - Ⓐ Lift the filter that needs to be replaced.
 - Ⓑ Turn the filter counterclockwise until it loosens.
 - Ⓒ Pull the filter down and remove it.

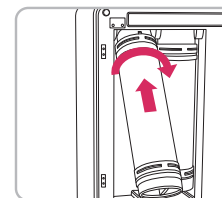

3. Put the new filter into the right position by turning it clockwise.

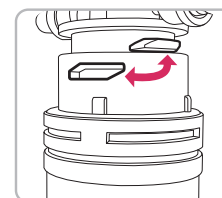

4. When installing the filter, the connection bump of the head and the connection groove on the top of the filter should be completely combined.

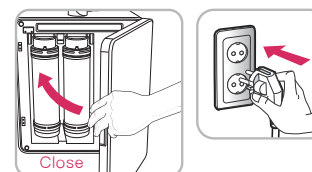

5. Close the door, plug the power cord back in and reengage the water supply.

After initializing the filter, press the H₂O button and run purified water for 3 minutes. It is highly recommended that you follow this process in order to ensure that your machine functions properly.

How to Reset the Filters

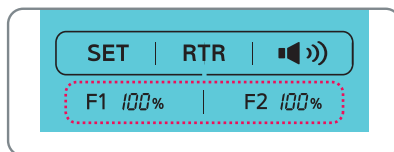

- ① Press the F1 or F2 filter icon for 3 seconds in order to reset the filters usage percentage back to 00%.
 - ※When you press and hold the F1 or F2 icon the unit will beep twice followed by a voice announcement.
 - ※Voice message: “1st or 2nd Filter / initializing was performed”
- ② When initialized normally, the corresponding filter usage on the display is displayed as 0%.

※ If you do not initialize the filter after replacing the filter, the corresponding filter change message will continue to operate.
 ※ After initializing the new filter/Reset the filter, press the H₂O button and run purified water for 3minutes.

Cleaning Function

For Keeping side of electrolytic cell clean, cleaning function performed in the following condition.

- 1 To keep the side of the electrolytic cell clean, a cleaning function will be performed.

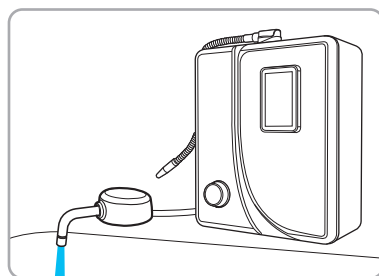

The cleaning function is performed after every 30ℓ of water is dispensed. Water outflows through the Drain Faucet only, and it will stop automatically when the washing time is done.

(Note: RTR icon and backlight will flicker before the automatic cleaning is performed)

※ Automatic cleaning will be performed after 1 ℓ of water is dispensed, and when you power up the unit.

- 2 Cleaning performed after using Acidic water or Turbo water

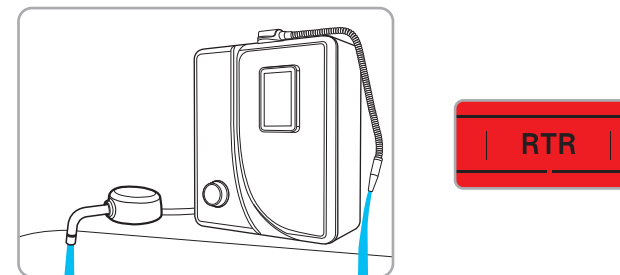

The cleaning function is performed after using Acidic water or Turbo water. Water outflows through the Water Outlet Tube and the Drain Faucet, and it will stop automatically when the washing time is done. **(Note:** RTR icon will flicker and the backlight will turn RED during the automatic cleaning cycle after the use of Acidic water or Turbo water).

※ Voice message: “It’s under washing, do not drink”

- 3 Cleaning performed before using Purified Water

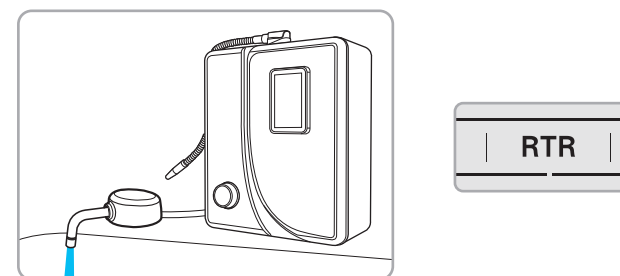

The cleaning function is performed before using Purified water. Water outflows through the Drain Faucet only. Purified water will come out automatically after the cleaning is performed. **(Note:** After using acidic water or turbo water, the cleaning is not performed since it has already been cleaned, as explained in number ②).

- 4 Cleaning performed when non-stop switched from Alkaline water to Hydrogen water

For adjusting the pH value, cleaning is performed when switched from Alkaline water to Hydrogen water without stopping outflow. Water outflows through the Drain Faucet only. Hydrogen water will come out automatically after cleaning.

Turbo Function

The TURBO function allows you to create strong alkaline and strong acidic water. These types of waters are ONLY to be used for cleaning, sanitizing, and disinfecting purposes. **NEVER DRINK THESE TYPES OF WATER.**



pH 3.0
~ pH 4.0



Used to Disinfect
and Sterilize



pH 10.0
~ pH 11.0



To remove stains from
fabrics/carpet/upholstery.

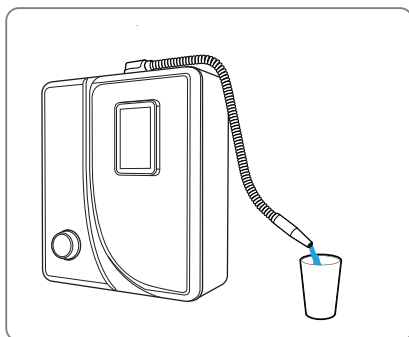

Alkaline Turbo Water Outflow

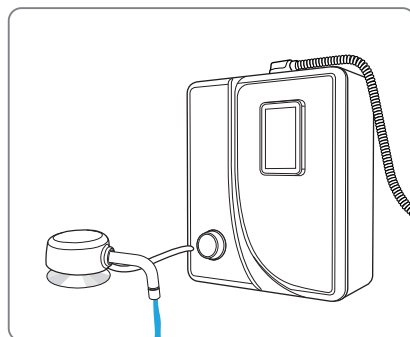

Acidic Turbo Water Outflow



- The waters produced in **TURBO** mode are not intended for drinking. **DO NOT DRINK** these types of waters.
- **DO NOT** Use the **TURBO** function in a manner other than directed.
- While operating the TURBO function, the machine will automatically stop dispensing water after 5 minutes. This feature prevents accidental overflow or flooding.

Unit specifications

Model Number	YT22-HA6
Electrolytic Cell Quantity of Poles	Alkaline Electrolyzer cell 1set, Hydrogen Electrolyzer cell 1set
Power Consumption	Max 120W
TURBO Function	O
Product Name	Hybrid Water Ionizer
Rated Voltage	100 -130 V~ <input checked="" type="checkbox"/> , 200 -240 V~ <input type="checkbox"/> / 50-60 Hz
Available temperature	4 -35°C (39 -95°F)
Operating Pressure Range	0.1- 0.5 MPa
pH Levels	2 Alkaline, 1 Hydrogen-Alkaline, 1 Neutral, 2 Acidic, 1 Hydrogen, Turbo Alkaline and Turbo Acid
Adjustable pH	User adjustable pH level control
Filters Configuration	Dual .01 Micron Filtration System
Filter Life Display	LCD filter replacement and announcement
Water Cell Plate Materials	Platinum and Titanium
Product Size	W300 x D135 x H355 mm (11.8 x 5.3 x 13.9 inches)
Product Weight	approx 5.5kg (12.1 Lbs)

※ To make the best functionality, there may be some change without notices.

Troubleshooting

Symptoms	Checkpoints	Measures to be Taken
Abnormal Taste	Check period of use	Run the unit for one minute, draining stagnant water
	Check the last time the filter was replaced	Replace the filter
	Check that pH is not higher than 10pH	Calibrate pH
Water Outflow Change	Check whether the valve on the water supply is closed	Open the Valve
	Check whether the hose is bent or folded	Stretch out the hose
	Check whether the flow rates are low (less than 1ℓ/ min)	Contact us to install a water pump
	Check whether the water supply is cut off or whether the water supply line is frozen	Wait until water comes out of the water supply pipe
	Check whether the filter is clogged	Change the filter
Incorrect pH levels	Check TDS of water	Water quality varies by region
	Check flow rates for higher levels	Reduce the amount of raw water
	Check whether the amount of drained water is small	Contact us. Request after-sales service
Filter replacement icon remains "on" even after filter has been replaced	Check whether the filter usage has been reset	Reset filter usage
Unit stops during use	Check whether the operating time exceeds 15 minutes (*Turbo function: 5 minutes)	Unit stops automatically after 15 minutes (*Turbo function: 5 minutes)
	Check the filter for proper mounting	Unplug unit Contact us
Unit leaks	Check other areas of the unit	
Settlement in extracted water	Check for excessive calcium in the source water	Contact us for an additional filter
Only purified water is extracted.	Check whether the flow rate is high (5 kgf/cil or faster)	Contact us to install a pressure-reducing valve
The screen turns off.	Check if non-operating time exceeds 10 minutes.	When non-using the unit for 10 minutes, it changes to the ECO mode automatically. The unit returns to normal after touching the screen.

Product Warranty

1. This product features a lifetime warranty. If any manufacturing defects or spontaneous failures occur during the warranty period, the unit will be repaired or replaced at no charge.
2. If any failure occurs, please call the service center. Note: The answers to many service questions can be found online at tyentusa.com/support.
3. In case of a failure resulting from the customer's negligence or intentional damage of the product, the customer shall be responsible for repair or replacement costs. The use of unapproved filters that are manufactured by a 3rd party will void the warranty.
4. Keep this document in a safe place as it is your Authentic Lifetime Warranty. This certificate extends the terms of the standard warranty, and ensures that your ionizer is guaranteed for life.
5. This warranty is non-transferable and valid only for the original owner.

Product Name	Product Model	Warranty Period
Hybrid Water Ionizer	<input checked="" type="checkbox"/> YT22-HA6	Lifetime (Above conditions apply)

Customer's Name/Phone	Date of Purchase
Customer's Address	Installation Date/Name



Tyent USA, LLC
www.tyentusa.com



137 Hurffville Crosskeys Rd, Sewell, NJ 08080
Toll Free: 855-TYENT-US